

AIWA CSD-ED37 SCHEMATIC DIAGRAM \_ 1 (MAIN 1/2)

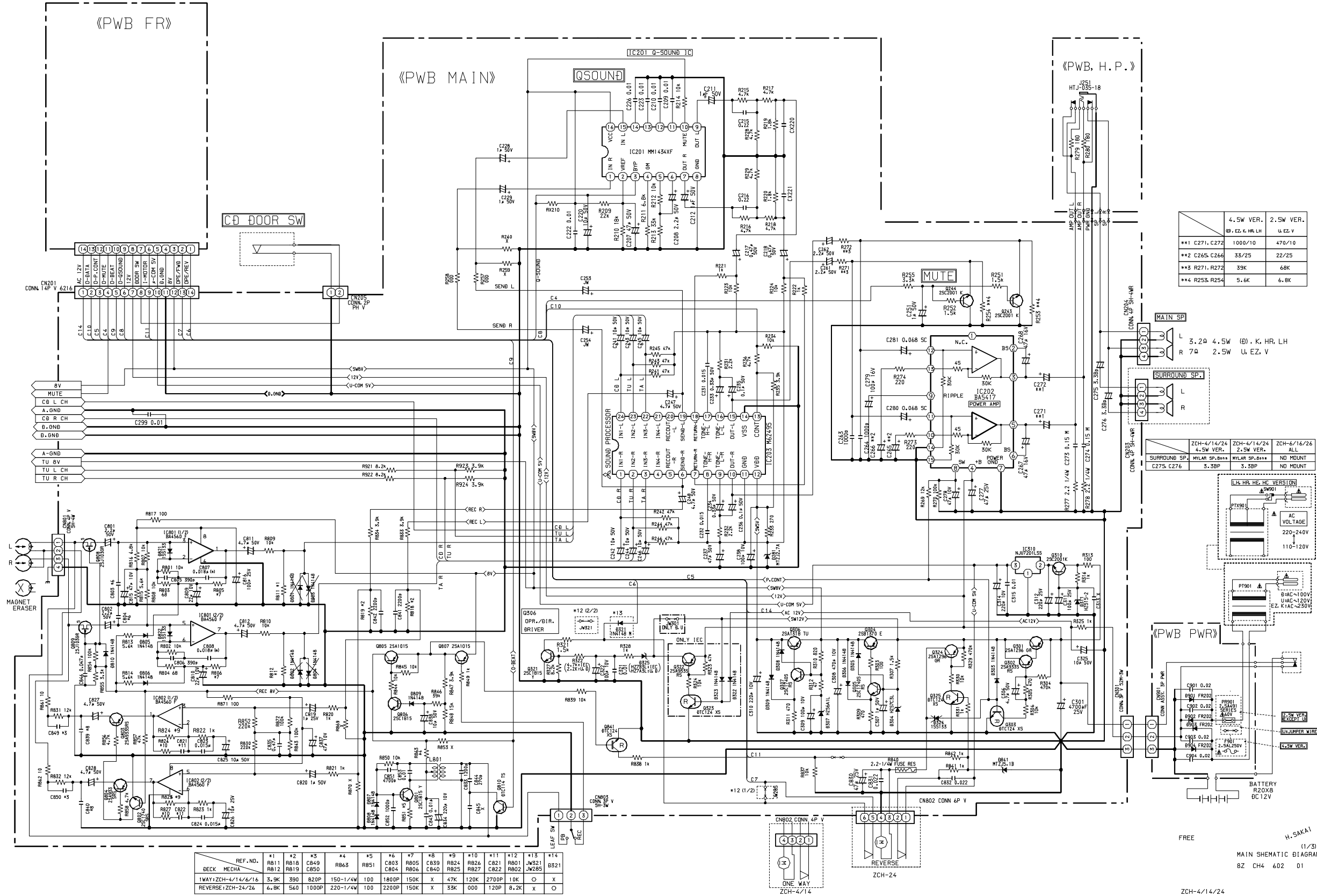

	4.5W VER.	2.5W VER.
**1	C271, C272	1000/10 470/10
**2	C265, C266	33/25 22/25
**3	R271, R272	39K 68K
**4	R253, R254	5.6K 6.8K

MAIN SP	L	3.2Ω	4.5W	(D) K. HR. LH
	R	7Ω	2.5W	U. EZ. V

	ZCH-4/14/24	ZCH-4/14/24	ZCH-6/16/26
SURROUND SP	4.5W VER.	2.5W VER.	ALL
	MYLAR SP.50mm	MYLAR SP.50mm	NO MOUNT
C275, C276	3.38P	3.38P	NO MOUNT

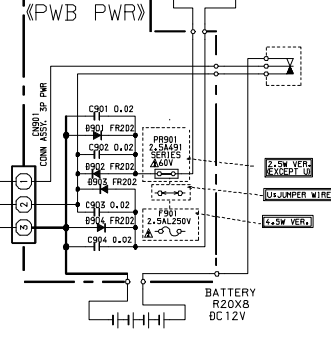
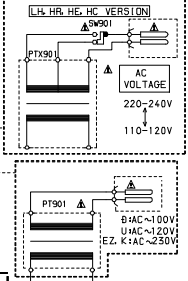

FREE H. SAKAI (1/3)  
MAIN SCHEMATIC DIAGRAM  
8Z CH4 602 01

ZCH-4/14/24

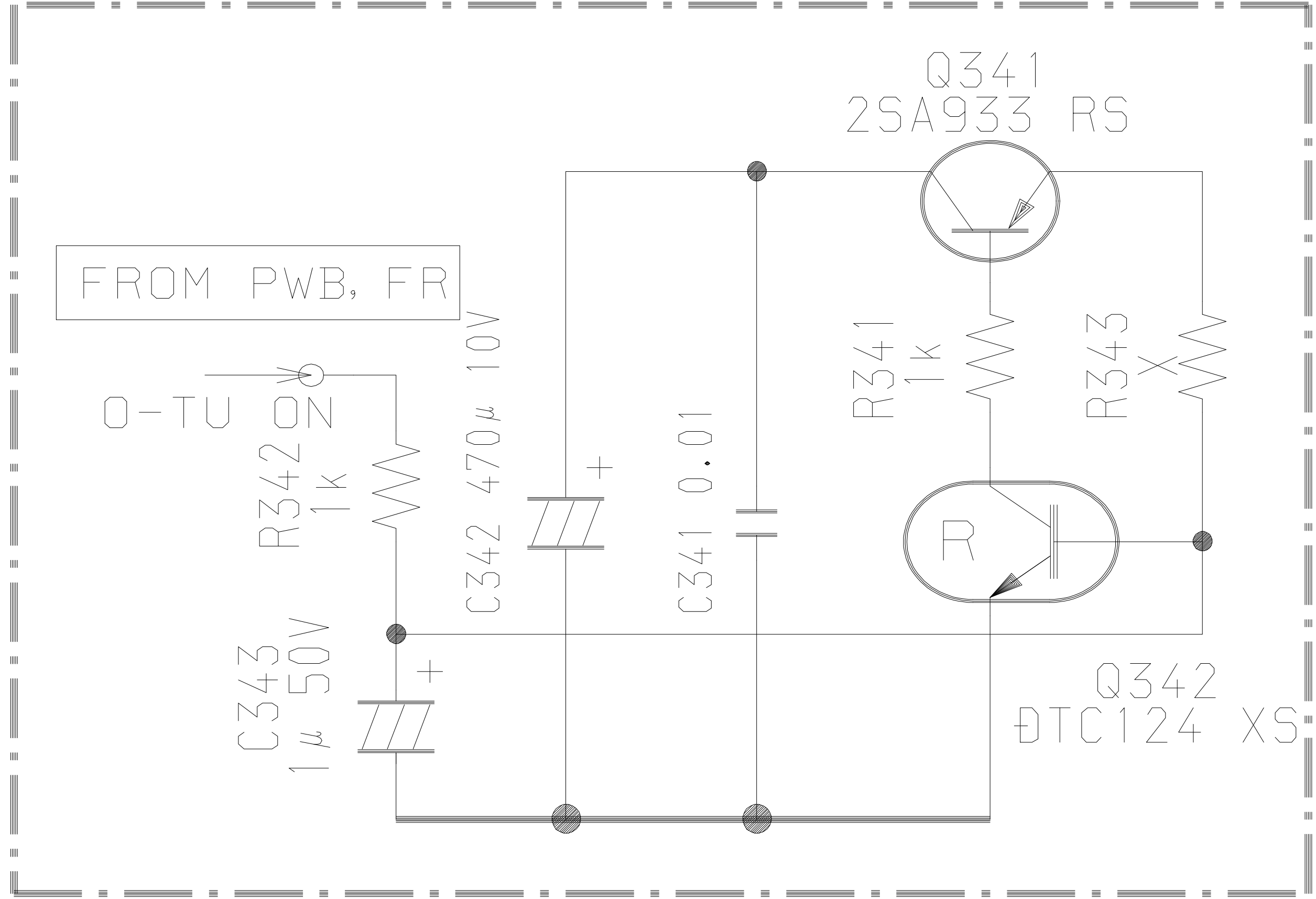

SCHEMATIC DIAGRAM - 3 (CD)

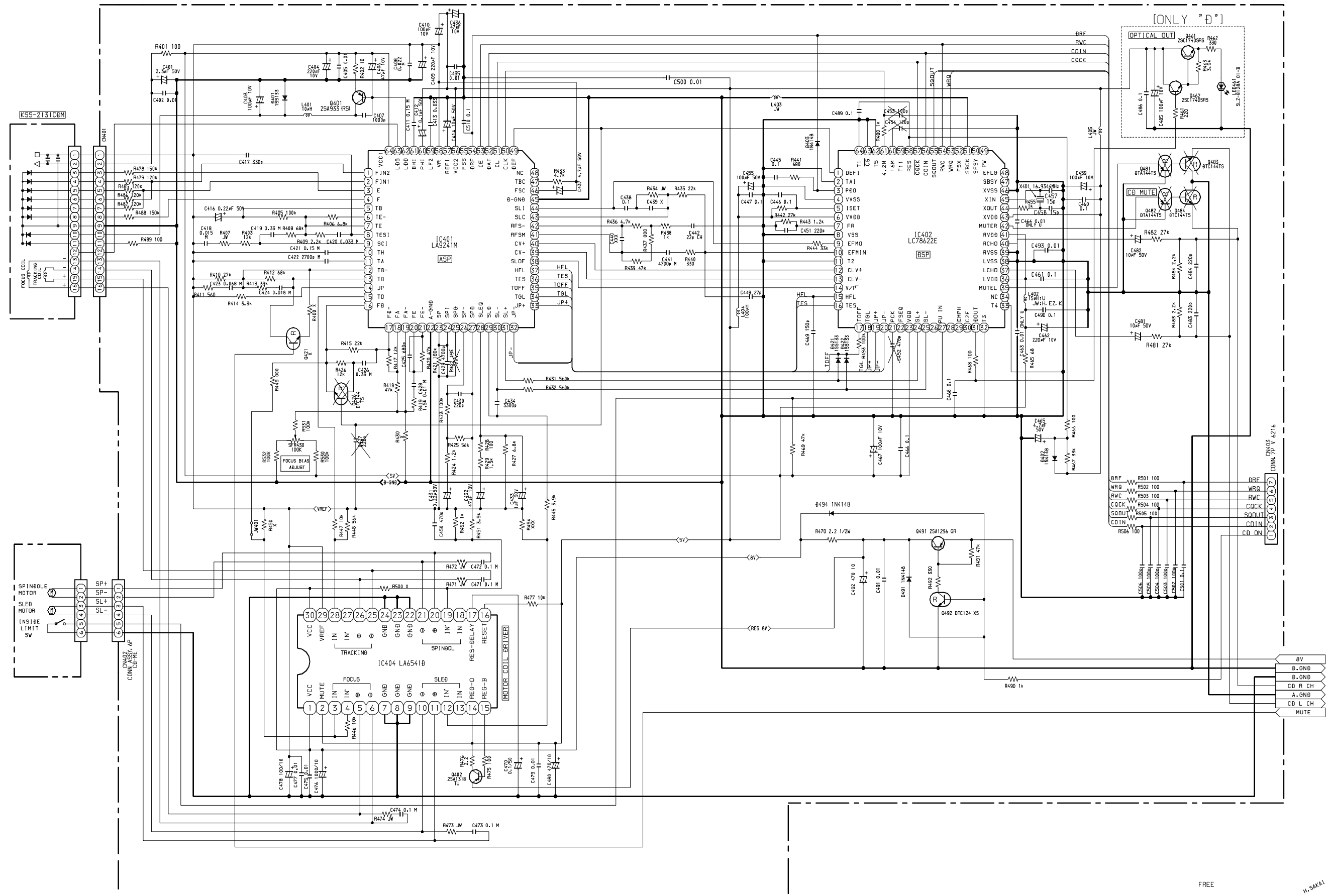

FREE  
94V0 H-5KAI

SCHEMATIC DIAGRAM - 4 (FRONT)

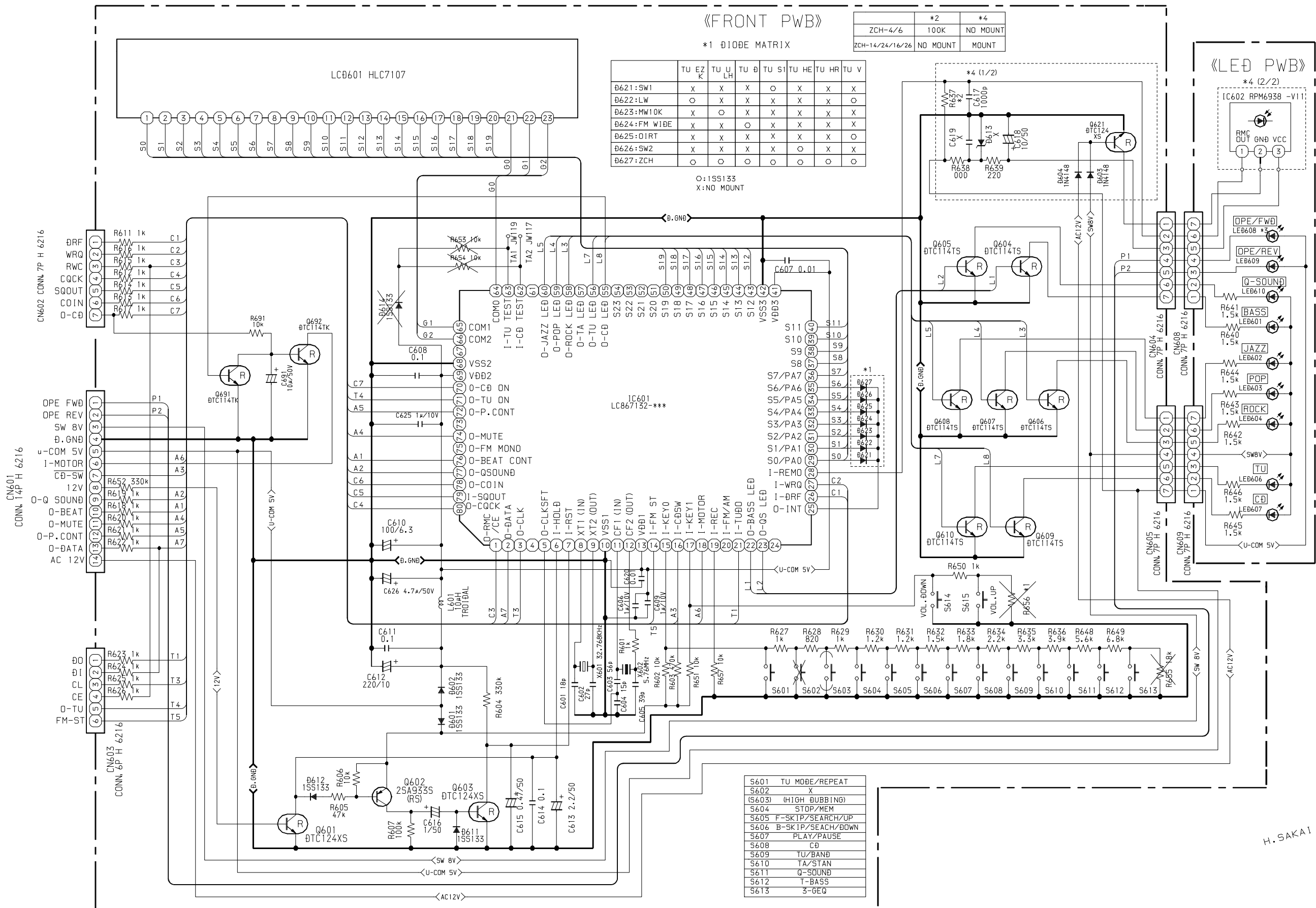

SCHEMATIC DIAGRAM - 5 (TUNER)

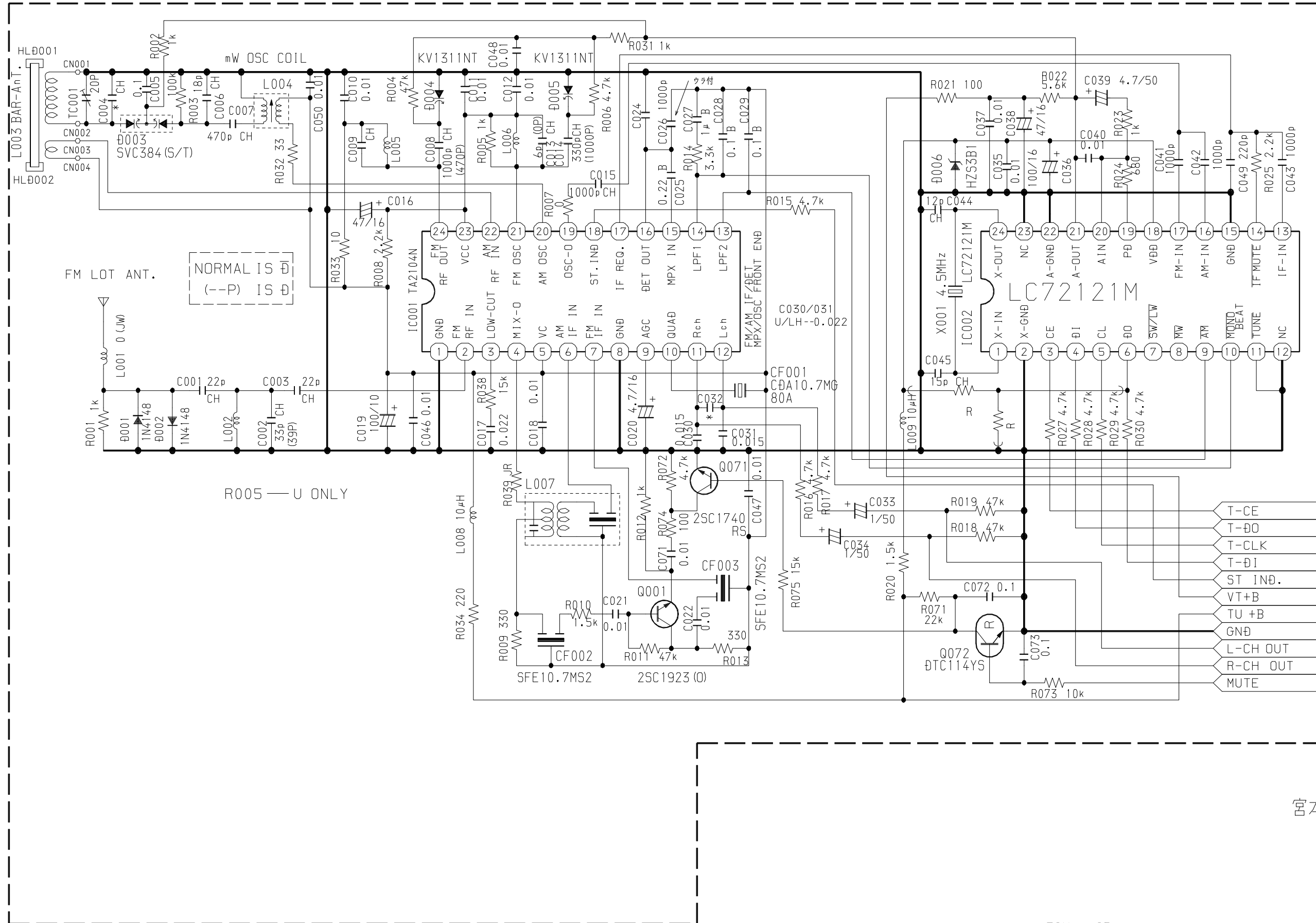

宮本

ZCH-\* -2B